

How to Measure Custom Luggage Cart Cover - Design 3

Measurement Instruction

- ✓ Give exact measurement from edge to edge.
- ✓ We add 1" to 2" leeway on the given width/depth for easy pull-in and pull-out.
- ✓ The height dimensions will remain same as provided by you.

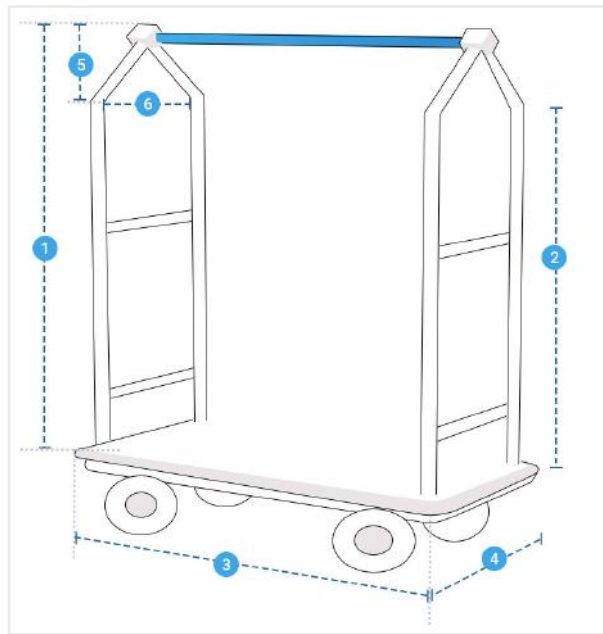

Measurement (Inches)

1. Height	<input type="text"/>	2. Height Till Edge	<input type="text"/>
3. Width	<input type="text"/>	4. Bottom Depth	<input type="text"/>
5. Height Till Hanger Rod	<input type="text"/>	6. Top Depth	<input type="text"/>

1. Height:
Height of the Custom Luggage Cart

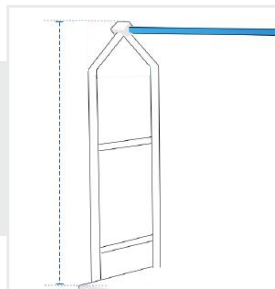

2. Height Till Edge:
Height Till Edge of the Custom Luggage Cart

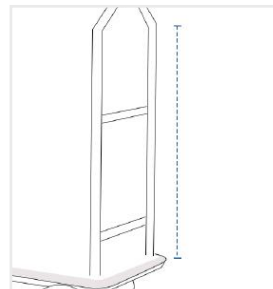

3. Width:
Width of the Custom Luggage Cart

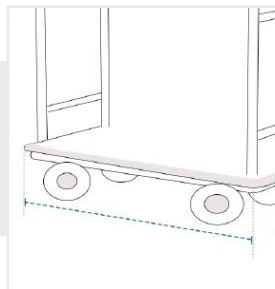

4. Bottom Depth:
Bottom Depth of the Custom Luggage Cart

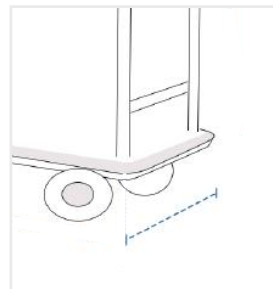

5. Height Till Hanger Rod:
Height Till Hanger Rod of the Custom Luggage Cart

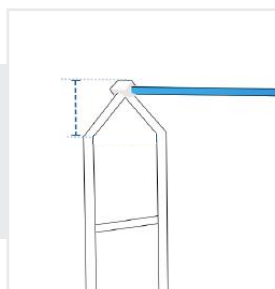

6. Top Depth:
Top Depth of the Custom Luggage Cart

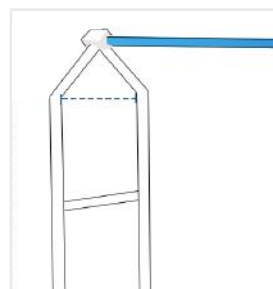

We encourage you to upload the image of the article you need the cover for - this helps our team ensure covers are designed keeping your requirements in mind.