

How to Measure Custom Chiminea Cover - Design 8

Measurement Instruction

- ✓ Give exact measurement from edge to edge.
- ✓ We add 0.5" to 1.5" leeway on the given width/depth for easy pull-in and pull-out.
- ✓ The height dimensions will remain same as provided by you.

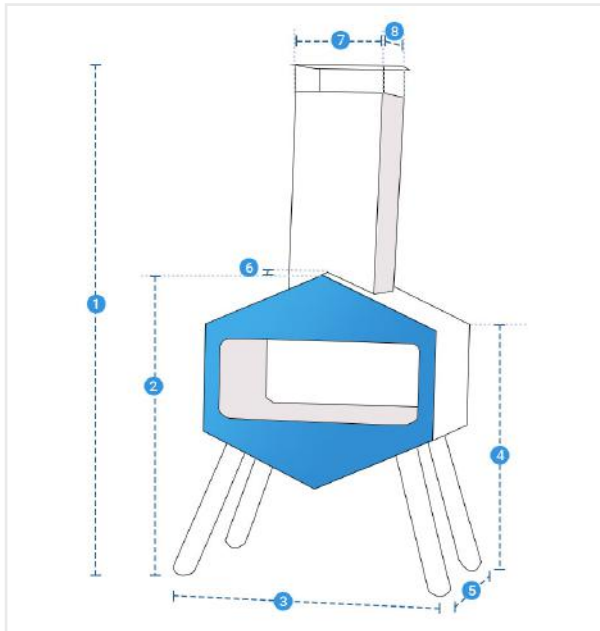

Measurement (Inches)

1. Height	<input type="text"/>	2. Height till Chiminea Pipe Bottom	<input type="text"/>
3. Bottom Width	<input type="text"/>	4. Height till Edge	<input type="text"/>
5. Bottom Depth	<input type="text"/>	6. Depth from Chiminea Pipe	<input type="text"/>
7. Width of Chiminea Pipe	<input type="text"/>	8. Depth of Chiminea Pipe	<input type="text"/>

1. Height:
Height of the Custom Chiminea

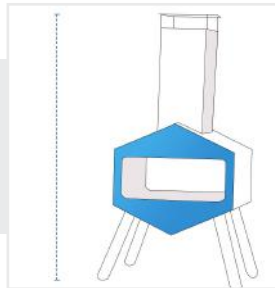

2. Top Hexagonal Slant Length 1:
Top Hexagonal Slant Length 1 of the Custom Chiminea

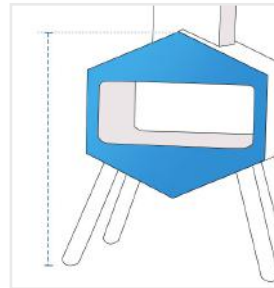

3. Bottom Width:
Bottom Width of the Custom Chiminea

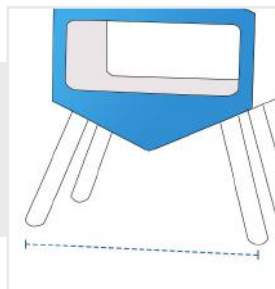

4. Height till Edge:
Height till Edge of the Custom Chiminea

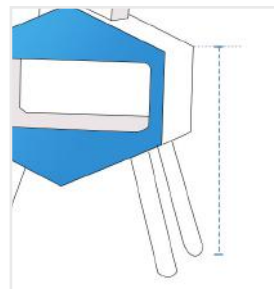

5. Bottom Depth:
Bottom Depth of the Custom Chiminea

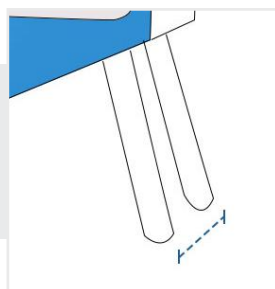

6. Depth from Chiminea Pipe:
Depth from Chiminea Pipe of the Custom Chiminea

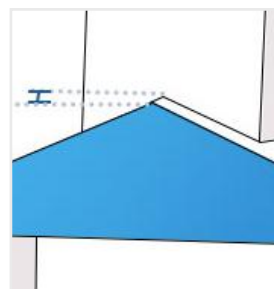

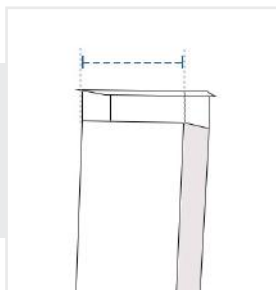

7. Width of Chiminea Pipe:
Width of Chiminea Pipe of the Custom Chiminea

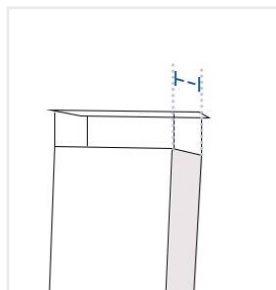

8. Depth of Chiminea Pipe:
Depth of Chiminea Pipe of the Custom Chiminea

We encourage you to upload the image of the article you need the cover for - this helps our team ensure covers are designed keeping your requirements in mind.

